

PRICE LIST 2026

English – (€) Eur

Last update: **March 2026**

KESS3

ECM TITANIUM

POWERGATE 4

ACADEMY

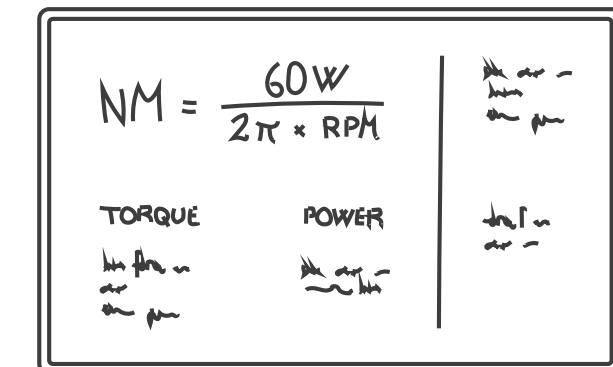
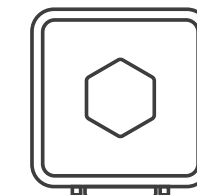
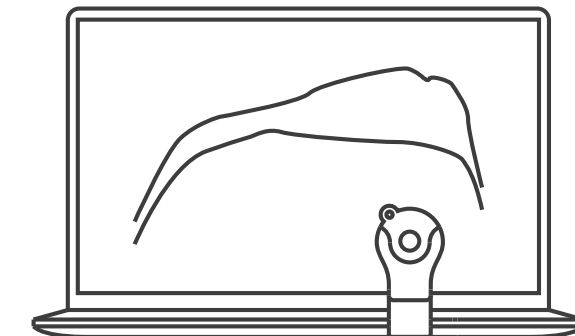
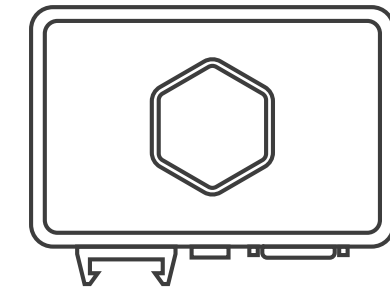

All in one tool: ECU and TCU programming via OBD, Bench and Boot mode.

Thanks to thirty years of experience and nearly three years of development, KESS3 is the most advanced engineering achievement ever conceived in the Chiptuning industry.

KESS3 has been developed to provide everyone with a quick and simple interface to any engine control unit and automatic gearbox on the market.

New microprocessor, latest generation I/O interfaces, new built-in sensors and high-performance EEPROM and FLASH memories are the main features of KESS3.

TOOL



MASTER VERSION



SLAVE VERSION



DYNODRIVE VERSION



SUBSCRIPTION AND SERVICES

ACCESSORIES



EVALUATE AND TRADE-IN YOUR KESSv2 and K-TAG

Unlock the value of your Alientech tool
and convert it to a new KESS3

Visit [alientech-tools.com](https://www.alientech-tools.com)

KESS3 - MASTER

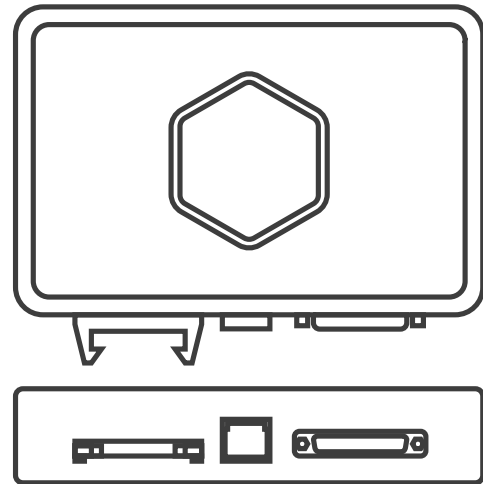

KESS3 combines 3 operating modes in a single device. OBD, Bench & Boot Mode. Configure it according to your requirements and work. Initialize your KESS3 as required by choosing your vehicles of interest and exploring all the possible configurations.

Code	Product	Price (EUR)
KESS3HW000	Hardware	700,00€



Code	Product	Price (EUR)
KESS3MA010	KESS3 Master - Car - LCV OBD-Bench-Boot Protocols activation "Bundle"	3.390,00 €
KESS3MA011	KESS3 Master - Bike - ATV & UTV OBD-Bench-Boot Protocols activation "Bundle"	1.490,00 €
KESS3MA012	KESS3 Master - Agriculture - Truck & Buses OBD-Bench-Boot Protocols activation "Bundle"	3.390,00 €
KESS3MA013	KESS3 Master - Marine & PWC OBD-Bench-Boot Protocols activation "Bundle"	1.490,00 €

Code	Product	Price (EUR)
KESS3MAB01	KESS3 Master - FULL OBD Protocols activation	4.490,00 €
KESS3MAB02	KESS3 Master - FULL Bench-Boot Protocols activation	3.490,00 €

All activations on a new hardware include 12 months of subscription.
All activations added to an already configured hardware will inherit the expiry date of the existing activation.

Single activation

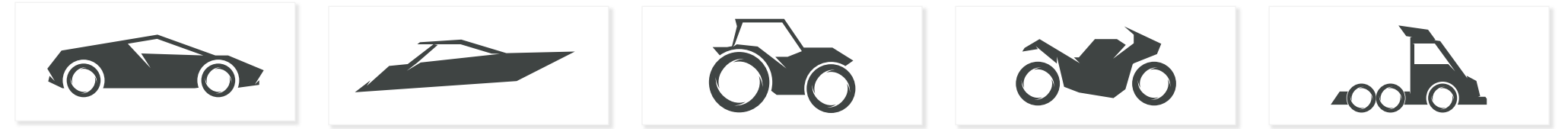

Code	Product	Price (EUR)
KESS3MA001	KESS3 Master - Car - LCV OBD Protocol activation	2.990,00 €
KESS3MA002	KESS3 Master - Bike - ATV & UTV OBD Protocol activation	1.290,00 €
KESS3MA003	KESS3 Master - Agriculture - Truck & Buses OBD Protocol activation	2.990,00 €
KESS3MA004	KESS3 Master - Marine & PWC OBD Protocol activation	1.290,00 €
KESS3MA005	KESS3 Master - Car - LCV Bench-Boot Protocol activation	2.490,00 €
KESS3MA006	KESS3 Master - Bike - ATV & UTV Bench-Boot Protocol activation	890,00 €
KESS3MA007	KESS3 Master - Agriculture - Truck & Buses Bench-Boot Protocol activation	2.490,00 €
KESS3MA008	KESS3 Master - Marine & PWC Bench-Boot Protocol activation	890,00 €

All activations on a new hardware include 12 months of subscription.
All activations added to an already configured hardware will inherit the expiry date of the existing activation.

KESS3 - TCU

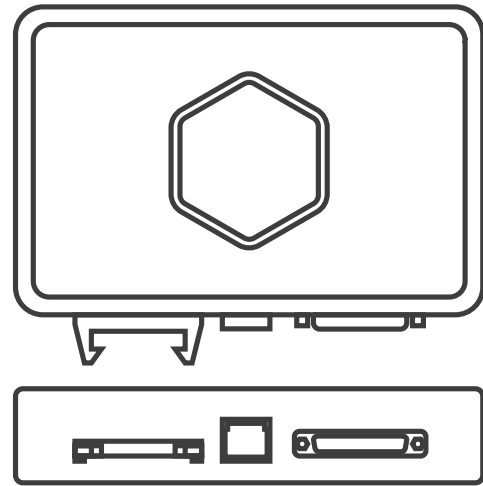

KESS3 combines 3 operating modes in a single device. OBD, Bench & Boot Mode. Activate the TCU configuration to work on the automatic transmissions of thousands of vehicles.

Code	Product	Price (EUR)
KESS3HW000	Hardware	700,00€

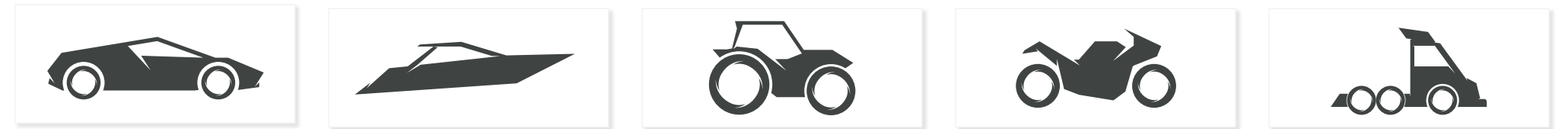

Code	Product	Price (EUR)
KESS3MATCU	KESS3 Master - TCU Protocol activation	1.290,00 €

All activations on a new hardware include 12 months of subscription.
All activations added to an already configured hardware will inherit the expiry date of the existing activation.

KESS3 - SLAVE

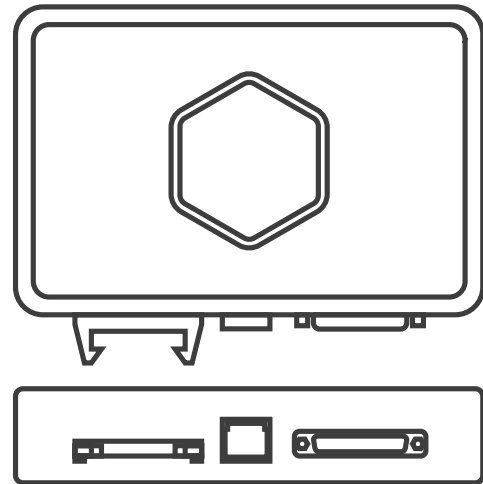

The files read by the «Slave» version encoded. This means that you exclusively work with modified files provided by your reference «Master».

KESS3 combines 3 operating modes in a single device. OBD, Bench & Boot Mode. Configure it according to your requirements and work. Initialize your KESS3 as required by choosing your vehicles of interest and exploring all the possible configurations.

Code	Product	Price (EUR)
KESS3HW000	Hardware	700,00€



Code	Product	Price (EUR)
KESS3SA010	KESS3 Slave - Car - LCV OBD-Bench-Boot Protocols activation "Bundle"	1.690,00 €
KESS3SA011	KESS3 Slave - Bike - ATV & UTV OBD-Bench-Boot Protocols activation "Bundle"	690,00 €
KESS3SA012	KESS3 Slave - Agriculture - Truck & Buses OBD-Bench-Boot Protocols activation "Bundle"	1.690,00 €
KESS3SA013	KESS3 Slave - Marine & PWC OBD-Bench-Boot Protocols activation "Bundle"	690,00 €

Code	Product	Price (EUR)
KESS3SAB01	KESS3 Slave - FULL OBD Protocols activation	2.190,00 €
KESS3SAB02	KESS3 Slave - FULL Bench-Boot Protocols activation	1.590,00 €

All activations on a new hardware include 12 months of subscription.
All activations added to an already configured hardware will inherit the expiry date of the existing activation.

Single activation



Code	Product	Price (EUR)
KESS3SA001	KESS3 Slave - Car - LCV OBD Protocol activation	1.290,00 €
KESS3SA002	KESS3 Slave - Bike - ATV & UTV OBD Protocol activation	590,00 €
KESS3SA003	KESS3 Slave - Agriculture - Truck & Buses OBD Protocol activation	1.290,00 €
KESS3SA004	KESS3 Slave - Marine & PWC OBD Protocol activation	590,00 €
KESS3SA005	KESS3 Slave - Car - LCV Bench-Boot Protocol activation	990,00 €
KESS3SA006	KESS3 Slave - Bike - ATV & UTV Bench-Boot Protocol activation	390,00 €
KESS3SA007	KESS3 Slave - Agriculture - Truck & Buses Bench-Boot Protocol activation	990,00 €
KESS3SA008	KESS3 Slave - Marine & PWC Bench-Boot Protocol activation	390,00 €

All activations on a new hardware include 12 months of subscription.
All activations added to an already configured hardware will inherit the expiry date of the existing activation.

KESS3 - DYNODRIVE

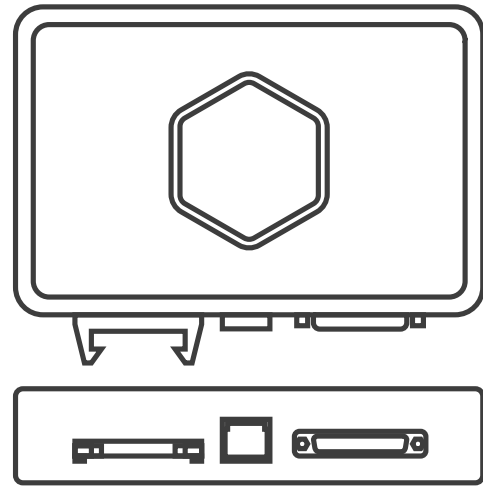

Get KESS3 hardware only with DynoDrive activation, thus configuring the tool even just to support power testing.

DynoDrive doesn't require any subscription and can be activated on KESS3 Hardware, Master and Slave independently of the activations that are already active on the tool.

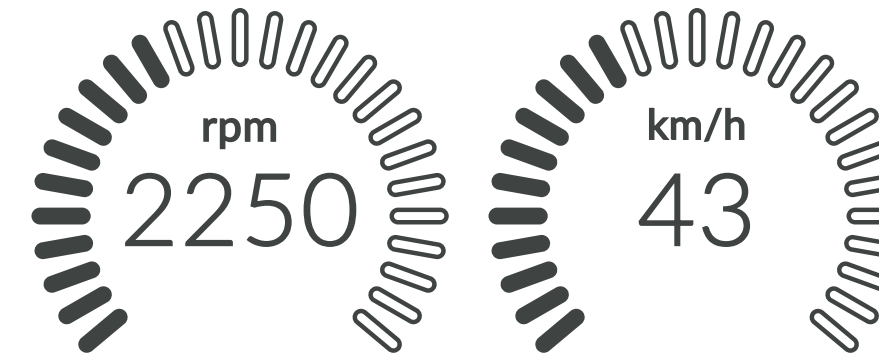

DynoDrive is an advanced feature, exclusive to Alientech Suite and KESS3, which allows for calculating and verifying performance while driving a vehicle.

Through the OBD diagnostic port and data acquisition from the integrated GPS module, DynoDrive provides power and torque values of a car that can be exported and compared endlessly on reserved area.

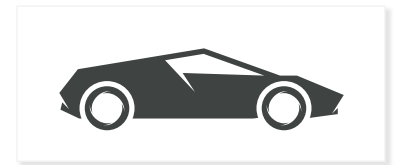

Code	Product	Price (EUR)
KESS3HW000	Hardware	700,00€

DynoDrive activation – KESS3 Hardware

Code	Product	Price (EUR)
KESS3PKW0	KESS3 Hardware – DynoDrive Activation	390,00 €

DynoDrive activation – KESS3 Master & Slave

Code	Product	Price (EUR)
KESS3MKW0	KESS3 Master – DynoDrive Activation	390,00 €
KESS3SKW0	KESS3 Slave – DynoDrive Activation	390,00 €

KESS3 - SUBSCRIPTION AND SERVICES

The activation of new protocols, the virtual reading service, web services related to the protocol functioning and technical assistance are services available with an active subscription. The subscription is unique and there is no distinction between the types of vehicles, or the communication methods purchased. The only discriminating factor is the tool version and the subscription length.

KESS3 MASTER

Code	Product	Price (EUR)
KESS3MS101	KESS3 Master - 12-month subscription – Renewal*	1.190,00 €
KESS3MS102	KESS3 Master - 12-month subscription – Early renewal**	990,00 €
KESS3MS103	KESS3 Master - 12-month subscription – Reactivation***	1.390,00 €

KESS3 SLAVE

Code	Product	Price (EUR)
KESS3SS101	KESS3 Slave - 12-month subscription – Renewal*	590,00 €
KESS3SS102	KESS3 Slave - 12-month subscription – Early renewal**	490,00 €
KESS3SS103	KESS3 Slave - 12-month subscription – Reactivation***	690,00 €

* If the renewal is completed after the expiration date, the new 12-month period starts from the renewal date. The time between the previous expiration and the renewal is aligned within the subscription.

** If the renewal is completed within the active 12-month subscription period, the new period starts from the scheduled expiration date.

*** If the reactivation is completed after the expiration date, the new 12-month period starts from the reactivation date. The time between the previous expiration and the reactivation is aligned within the subscription.

Online Backup Management

Code	Product	Price (EUR)
KESS3MOBM0	KESS3 Master – Online Backup Management	390,00 €

Bespoke cables for OBD communication with every vehicle type and adapters and accessories to make your work easier for Bench mode connection.

Agriculture - Truck & Buses



Code	Product	Price (EUR)
144300K207	DAF 16 pin round cable	99,00 €
144300K208	DAF-MAN-SCANIA OBDII cable	99,00 €
144300K209	IVECO 30 pin round cable	99,00 €
144300K214	Renault Trucks OBDII 12 pin adapter cable	99,00 €
144300K215	SCANIA 16 pin round cable	99,00 €
144300K216	VOLVO Trucks LUCAS connector cable	149,00 €
144300K217	VOLVO Trucks - RENAULT Truck OBDII cable	99,00 €
144300K226	CNH - CUMMINS - John Deere 9 pin round cable	99,00 €
144300K227	John Deere Premium 9 pin round cable	99,00 €
144300K228	CNH - Valtra 8 pin round cable	99,00 €
144300K229	CNH - Valtra 16 pin round cable	99,00 €
144300K230	Massey Ferguson 16 pin round cable	99,00 €

Agriculture - Truck & Buses

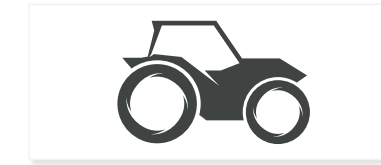

Code	Product	Price (EUR)
144300K231	FENDT CANbus 4 pin round cable (required 144300KPWR cable)	99,00 €
144300K232	SAME Deutz-Fahr 14 pin round cable	99,00 €
144300K233	FENDT 12 pin round cable	99,00 €
144300K234	MAN 37 pin round cable	99,00 €
144300K235	CUMMINS 9 pin round cable	99,00 €
144300K236	CUMMINS 16 pin cable	99,00 €
144300K237	MAN 12 pin round cable	99,00 €
144300K238	VOLVO Trucks VM connector cable	99,00 €
144300K245	CAT J1939 Data Link cable	99,00 €
144300K246	CAT - Perkins 9 pin round cable	99,00 €
144300K248	FENDT K-Line 4 pin round cable	99,00 €
144300K260	SAME Deutz-Fahr 19 pin round cable (required 144300KPWR cable)	189,00 €
144300K262	FENDT Deutz-Fahr 14 pin round cable	99,00 €
144300K273	Mercedes Trucks TEMIC OBD cable	139,00 €
144300K274	Mercedes Trucks TEMIC Bench cable (required 144300KPWR cable)	99,00 €
144300K277	Massey Ferguson 9 pin round cable	99,00 €
144300K285	Bobcat Delphi DCM3.7AP cable	99,00 €

Bike - ATV & UTV

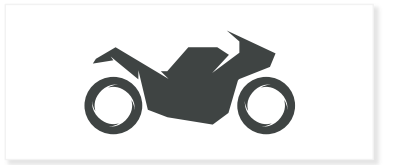

Code	Product	Price (EUR)
144300K241	Aprilia - Ducati - Piaggio - MV Agusta OBD cable	59,00 €
144300K244	Ducati Continental - Bosch - Melco 4 pin cable	59,00 €
144300K252	Husqvarna - KTM 6 pin cable	59,00 €
144300K256	Harley Davidson J1850 4 pin cable	59,00 €
144300K257	Harley Davidson CANbus 6 pin cable	59,00 €
144300K258	MV Agusta Eldor CANbus 4 pin cable	59,00 €
144300K263	Yamaha T-Max K-Line cable	59,00 €
144300K266	BMW Motorrad 14 pin round cable	59,00 €
144300K270	Honda - Keihin 3 pin cable	59,00 €
144300K271	Yamaha OBD cable	59,00 €
144300K272	Benelli OBD cable	59,00 €
144300K279	Kawasaki Euro4 6 pin cable	59,00 €
144300K280	KTM Euro5 cable	109,00 €
144300K281	6 pin cable ISO19689 Motorcycle OBD Standard	59,00 €
144300K284	Honda Keihin 38770-MKE OBD cable	59,00 €

Car - LCV

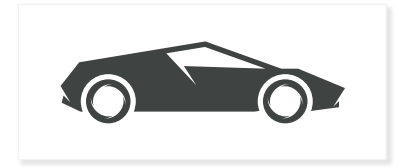

Code	Product	Price (EUR)
144300K239	Mitsubishi double-connector cable	79,00 €
144300K240	Subaru OBDII cable and jumpers	79,00 €
144300K254	VAG DSG DQ200 25 pin connector	189,00 €
144300K259	VAG DSG DQ500 16 pin connector	189,00 €
144300K265	VAG DSG DL501 16 pin connector	189,00 €
144300K267	VAG DSG DQ250-DQ250MQB 20 pin connector	169,00 €
144300KOBDD	OBD cable	59,00 €
144300KUNI	Universal cable	59,00 €
144300KPWR	Power supply cable with AMP superseal connector	59,00 €

Bench - Boot

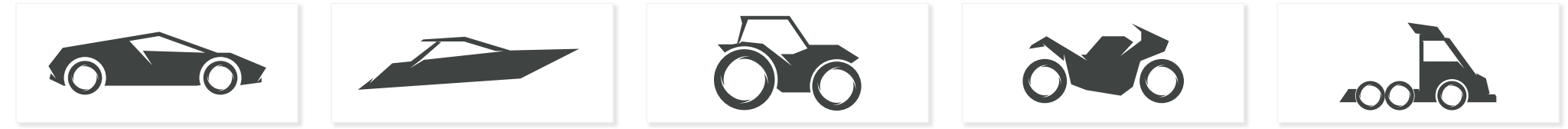

Code	Product	Price (EUR)
1400K3ALIM	Bench Power Supply	59,00 €
144300KBNC	Multiwire Cable for ECU connection	79,00 €
144300KTER	Extension for Multiwire Cable 144300KBNC	79,00 €
144300T100	Flat Cable	24,00 €
144300T101	Flat Cable	24,00 €
144300T102	Flat Cable	24,00 €
144300T103	Flat Cable	24,00 €
144300T104	Flat Cable IDC26-10	24,00 €
144300T105	Flat Cable IDC26-16	24,00 €
144300T106	Flat Cable IDC26-26	24,00 €
144300T107	Cable for Denso ECU (Renesas M32)	79,00 €
144300T109	SMD Grabber Probe (3 pieces)	139,00 €
144300T110	SMD Grabber Probe (1 piece)	99,00 €
144300T114	Cable for Bosch EDC7 ECU	24,00 €
144300T115	Cable for Volvo TRW Service Mode connection	199,00 €
144300TALI	External Battery Power Supply	24,00 €

Bench - Boot

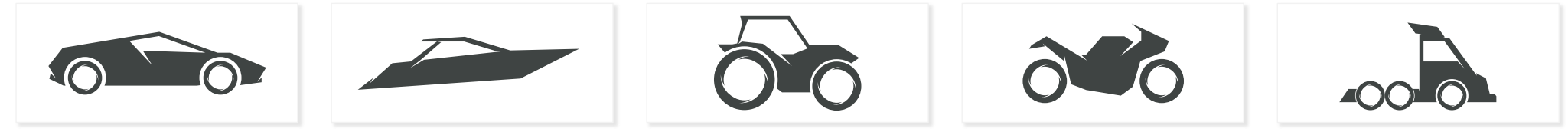

Code	Product	Price (EUR)
14AM00T00M	Adapter for Delphi DCM3.1 ECU (Motorola MPC5xx)	69,00 €
14AM00T01M	Adapter for Bosch ECU (Motorola MPC5xx)	69,00 €
14AM00T02M	Adapter for Delphi DCM3.2 ECU (Motorola MPC5xx)	69,00 €
14AM00T03M	Adapter for Bosch ECU (ST10Fxxx)	69,00 €
14AM00T05M	Adapter for Marelli ECU (Nexus MPC5xxx)	69,00 €
14AM00T06M	Adapter for Delphi ECU (Nexus MPC5xxx)	69,00 €
14AM00T07M	Adapter for Mitsubishi Denso ECU (Renesas SH705x -WR-)	69,00 €
14AM00T08M	Adapter for Mazda Denso ECU (Renesas SH705x -WR-)	69,00 €
14AM00T09M	Adapter for Nissan Denso ECU (Renesas SH705x -WR-)	69,00 €
14AM00T10M	Adapter for Mitsubishi Denso ECU (Renesas SH705x -RD-)	89,00 €
14AM00T11M	Adapter for Mazda-Nissan Denso ECU (Renesas SH705x -RD-)	99,00 €
14AM00T13M	Adapter for TRW Truck ECU (Nexus MPC5xxx)	99,00 €
14AM00T14M	Adapter for Lotus EFI T6 ECU (Nexus MPC5xxx)	69,00 €
14AM00T15M	Adapter for Denso ECU (NEC 76F00xx Board Type A)	99,00 €
14AM00T16M	Adapter for Denso ECU (NEC 76F00xx Board Type B)	99,00 €

Bench - Boot

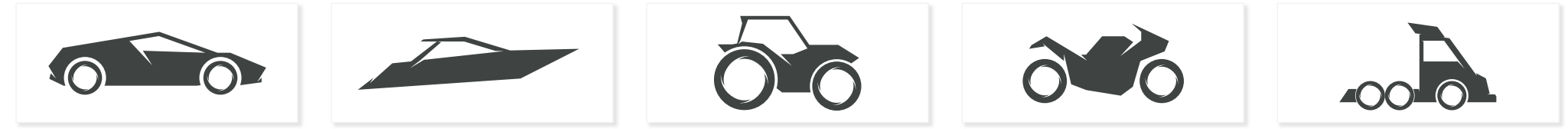

Code	Product	Price (EUR)
14AM00T18M	Adapter for Marelli ECU (Motorola MPC56xxx)	99,00 €
14AM00T24M	Adapter for Continental SID208-SID209 ECU (Infineon Tricore)	99,00 €
14AM00T25M	Adapter for Continental SID807 ECU (Infineon Tricore)	99,00 €
14AM00T28M	Multi-function Board (Renesas SH725xxx)	99,00 €
14AM00T29M	Pull-out (Renesas SH725xxx-36)	69,00 €
14AM00T30M	Pull-out (Renesas SH725xxx-26)	69,00 €
14AM00TB01	Siemens pull-out (Motorola MPC5xx)	69,00 €
14AM00TB02	Magneti Marelli pull-out (Motorola MPC5xx)	69,00 €
14AM00TB03	Bosch EDC7 pull-out (Motorola MPC5xx)	69,00 €
14AM00TBAS	Multi-function Board (Motorola MPC5xx)	69,00 €
14AS00T02S	Soldering Adapter for TRW Truck ECU (Motorola MPC5xx)	69,00 €
14AS00T10S	Soldering Adapter for Denso ECU (Renesas SH705x)	69,00 €
14P600KT04	Adapter for Bosch EDC17-MED17 ECU (Infineon Tricore)	99,00 €

Bench - Boot



Code	Product	Price (EUR)
144300K275	Continental HDEP MCM2.1 cable	139,00 €
144300K276	Temic ACM2.1 cable	139,00 €
144300TADP	Adapter for 144300T116 and 144300T117 cable	59,00 €
144300KTCU	TCU extensions for Multiwire Cable 144300KBNC	59,00 €
14P800ADB2	Upper illumination deck upgrade	99,00 €
14P800ADB3	Programming probes kit	69,00 €
14P800DIMA	Alientech Dima Positioning Frame	290,00 €

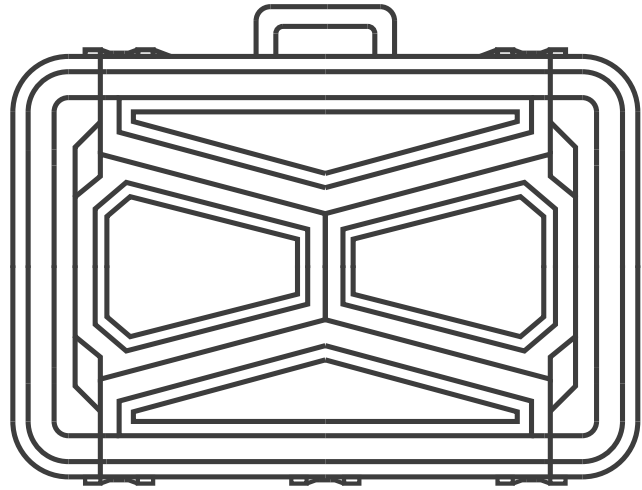

Suitcase

Code	Product	Price (EUR)
KESS3GEAR0	KESS3 accessory storage case	69,00 €
KESS3CASE0	KESS3 replacement suitcase (basic accessories not included)	159,00 €

ECM TITANIUM

ALIENTECH[®]

The performance configurator for motor vehicles that you can use wherever and whenever you want.

ECM TITANIUM is the recalibration software developed by Alientech, which allows you to independently view and modify the management parameters of any original ECU and TCU calibration file. With different working views (2D, 3D, TAB and Driver), ECM Titanium allows you to act not only for performance enhancement but also for ECU repairing and cloning.

VERSION



DRIVER MAKER

**SUBSCRIPTION AND
CREDITS**

ECM TITANIUM - VERSION

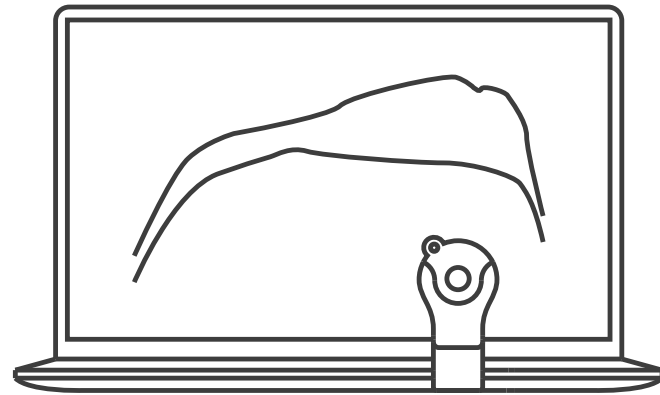

ECM TITANIUM Full.

A comprehensive solution in which you have dedicated technical assistance, up to 100 drivers per day available for download for cars, bikes, tractors, trucks, and boats.

You can request Original Files and New Drivers, update the drivers list and the software. If you choose the Full version, you have everything at your disposal and you are free to remap without restriction.

ECM TITANIUM Credits.

Activate your ECM TITANIUM software with Credits and choose the operations that interest you the most. Do you need a motorbike or gearbox driver? Use some of your credits only! You maintain control over what you do and, depending on your needs, you can expand your “credit package”.

Feature	ECM TITANIUM CREDIT	ECM TITANIUM FULL / PROMO*
ECM Titanium security key	Included (250,00 €)	Included (250,00 €)
Software update	Included	Included
Drivers update	Included	Included
Technical assistance	-	Included
Original File Download	-	Included
New Driver request	Included	Included
Driver download	40 credits	Included

Code	Product	Price (EUR)
149967TIFL	ECM Titanium - Security Key	250,00 €
149757EC16	ECM Titanium - Full version* (Activation + Security Key 149967TIFL required)	2.140,00 €
149757EC17	ECM Titanium - Full Promo** version (Activation + Security Key 149967TIFL required)	940,00 €
149757EC19	ECM Titanium - Credit* version (Activation + Security Key 149967TIFL required)	640,00 €

* The Full version includes 12 months of subscription. The Credit version includes 1000 credits.

** The Full Promo version is available only in association with KESS3 Master.

ECM TITANIUM – UPGRADE AND ADDITIONAL FUNCTIONS

UPGRADE

Code	Product	Price (EUR)
149757EC11	Upgrade ECM Titanium - From Credit to Full*	1.590,00 €
149757EC18	Upgrade ECM Titanium - From Credit to Full promo**	310,00 €
149757EC20	Upgrade ECM Titanium - From Full promo to Full***	1.290,00 €

* Upgrading from Credit to Full version is only possible if you already own the active Security Key in Credit version. The Upgrade includes the renewal of the ECM Titanium subscription for 12 months.

** Upgrading from Credit version to Full promo is only possible if you already own the active Security Stick in Credit version and if you own KESS3 Master or if you purchase it in combination.

The Upgrade includes the renewal of the ECM Titanium subscription for 12 months.

*** Upgrading from Full promo to Full version is only possible if you already own the active security key in Full promo version. The Upgrade does not include the renewal of the ECM Titanium subscription.

PLUGIN DRIVER MAKER

If you wish to make the most of ECM TITANIUM and be more independent when generating your remaps, Driver Maker is right for you.

This is a plugin for creating new drivers or modifying our existing drivers in the Alientech databank.

Code	Product	Price (EUR)
149757ECMD	ECM Titanium - Driver Maker Plugin	450,00 €

ECM TITANIUM - SUBSCRIPTION AND CREDITS

The remapping drivers and the technical assistance are subscription-based services available only with ECM Titanium FULL.

ECM TITANIUM SUBSCRIPTION

Code	Product	Price (EUR)
18C7570001	ECM Titanium - 12 months of subscription	590,00 €
18C757EC06	ECM Titanium - 6 months of subscription	350,00 €

ECM TITANIUM CREDITS

Code	Product	Price (EUR)
149757EC12	ECM Titanium - 1x Download credit for Driver (min. 40)	1,00 €
149757EC13	ECM Titanium - 200x Download credit for Driver	180,00 €
149757EC14	ECM Titanium - 400x Download credit for Driver	320,00 €
149757EC15	ECM Titanium - 800x Download credit for Driver	560,00 €

POWERGATE 4

ALIENTECH[®]

Full customization anywhere and anytime through OBD socket.

Powergate 4 is the innovative solution for improving vehicle's performance or reducing fuel consumption directly from the smartphone through the Powergate App for Android, iOS, and EMUI (Huawei). Thanks to your modified files, Powergate 4 User will be able to boost the performance of its vehicle, in complete autonomy and safety with more fun.

TOOL



ACCESSORIES



POWERGATE 4

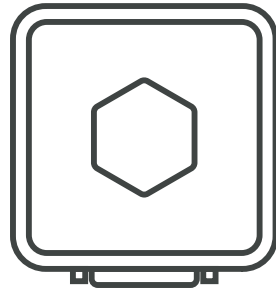

The price of the single activation varies according to the quantity purchased, the OBDII standard cable (144300KOB) is included.
The correct cable to associate is available as an accessory to be purchased separately.

Code	Product	Price (EUR)
PWG4KIT000	Hardware - User Unit	89,00 €

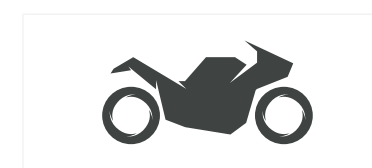
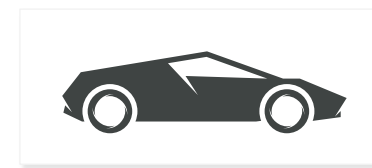

Code	Product	Price (EUR)
PWG4UUL009	Activation - User Unit License (1-9x)	210,00 €
PWG4UUL049	Activation - User Unit License (10-49x)	180,00 €
PWG4UUL099	Activation - User Unit License (50-99x)	150,00 €
PWG4UUL499	Activation - User Unit License (100-499x)	120,00 €
PWG4UUL500	Activation - User Unit License (500 - Over)	70,00 €

POWERGATE 4

The price of the single activation varies according to the quantity purchased, the OBDII standard cable (144300KOBD) isn't included.
The correct cable to associate is available as an accessory to be purchased separately.

Code	Product	Price (EUR)
PWG4KIT001	Hardware - User Unit "No OBD Cable"	79,00 €

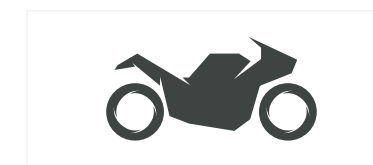
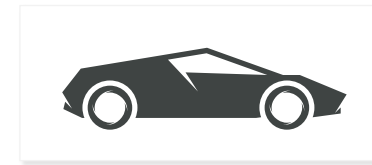

Code	Product	Price (EUR)
PWG4NOC009	Activation - User Unit "No OBD Cable" License (1-9x)	180,00 €
PWG4NOC049	Activation - User Unit "No OBD Cable" License (10-49x)	150,00 €
PWG4NOC099	Activation - User Unit "No OBD Cable" License (50-99x)	120,00 €
PWG4NOC499	Activation - User Unit "No OBD Cable" License (100-499x)	90,00 €
PWG4NOC500	Activation - User Unit "No OBD Cable" (500 - Over)	40,00 €

USER CANCELLATION CREDIT

Code	Product	Price (EUR)
PWG4SWA001	Powergate 4 User cancellation credit	99,00 €

Bike - ATV & UTV

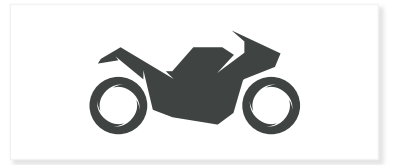

Code	Product	Price (EUR)
144300K241	Aprilia - Ducati - Piaggio - MV Agusta OBD cable	59,00 €
144300K244	Ducati Continental - Bosch - Melco 4 pin cable	59,00 €
144300K252	Husqvarna - KTM 6 pin cable	59,00 €
144300K256	Harley Davidson J1850 4 pin cable	59,00 €
144300K257	Harley Davidson CANbus 6 pin cable	59,00 €
144300K258	MV Agusta Eldor CANbus 4 pin cable	59,00 €
144300K263	Yamaha T-Max K-Line cable	59,00 €
144300K266	BMW Motorrad 14 pin round cable	59,00 €
144300K270	Honda - Keihin 3 pin cable	59,00 €
144300K271	Yamaha OBD cable	59,00 €
144300K272	Benelli OBD cable	59,00 €
144300K279	Kawasaki Euro4 6 pin cable	59,00 €
144300K280	KTM Euro5 cable	109,00 €
144300K281	6 pin cable ISO19689 Motorcycle ODB Standard	59,00 €
144300K284	Honda Keihin 38770-MKE OBD cable	59,00 €

Professional training to beat the competitors.

Alientech Academy is our professional training platform that will allow you, whatever the mode of use (class, virtual and online), to learn technical and practical know-how about the world of reprogramming, offering your customers the best services.

ECM TITANIUM: HOW TO USE

Thanks to this course you will have the opportunity to deepen your knowledge of the Alientech ECM Titanium software and to understand the operational strategies used by diesel and petrol engine control units.

We will analyze the many systems present in the new generation engines, to understand how and with which maps the ECU controls the performance developed by the vehicle. In addition, you will understand what are the practical procedures and basic techniques to perform remapping of diesel and petrol engines.

MORE INFORMATION ON REMAPPING PETROL ENGINES

This course will allow you to deepen even more your skills for the modification of petrol engine control units and to understand what are any limits present in other units, which do not allow you to unlock the maximum potential of the vehicle.

You will understand how to calculate the maximum possible increment on any stock engine and what specific modification procedures have been applied to some selected practical examples. In addition, we will see how to use the software ECM Titanium for the comparison of original files with different powers.

MORE INFORMATION ON REMAPPING DIESEL ENGINES

This frontal course will allow you to delve even further into your skills for modifying Diesel Engine Control Units and to understand how to avoid various issues such as, for example, torque monitoring.

You will understand how to calculate the maximum possible increment on any stock engine and what specific modification procedures have been applied to some selected practical examples, and then test the modified file created, on the test bench. Finally, we will see how to use the software ECM Titanium for the comparison of original files with different powers.

MORE INFORMATION ON BIKE REMAPPING

This course will allow you to deepen even more your skills for tuning motorcycles engine control units and to better understand their components logic.

You will learn about engine parameters to be modified and which tuning procedures are applied on some practical examples. Moreover, we will see how to use ECM Titanium software to tune the necessary maps.

$$NM = \frac{60W}{2\pi \times RPM}$$

TORQUE POWER

Basic Training

Code	Product	Price (EUR)
CF00570009	Basic Training - Chiptuning basics & Alientech tools	290,00 €
CF00570011	Basic Training - ECM Titanium & Tuning basics	290,00 €

Advanced Training - Car

Code	Product	Price (EUR)
CF00570012	Advanced Training - Petrol mapping	390,00 €
CF00570013	Advanced Training - Diesel mapping	390,00 €

Visit alientech-tools.com for the updated calendar

PRICE LIST 2026

Language: **English**
Currency: **Euro (€)**
Last update: **March 2026**

HEADQUARTER



Alientech – ITALY

Via dei Cordari 1, 13039 - Trino (VC)

+39 0161801025 - info@alientech.to

REGIONAL OFFICES



Alientech – SPAIN

Avenida de José Ortega y Gasset,
124, 29006 Málaga

+34 952038683
info@alientech.es



Alientech – FRANCE

32 rue Magny-Cours
81600 Montans

+33 563553958
info@alientech.fr



Alientech – UK

Silverstone Park, Innovation Centre,
Towcester, Northampton, NN128GX

+44 01327 640150
info@alientech.uk.com



Alientech – USA

2110 Reynolds Lane
Louisville, Kentucky 40218

+1 5028830121
chris@alientech-usa.com



Alientech – AUSTRALIA

3 Gumleaf Court
Burpengary QLD 4505

+61 0450854994
sales@alientechbrisbane.com.au



Alientech – CHILE

Avenida Pedro Fontova 7309
Huechuraba Santiago

+56958188464
alientechchile@gmail.com



Alientech – BRAZIL

Rua São Paulo, 1920 - Centro
Cascavel, PR, 85801-021

+452101-7997
contato@alientechbrasil.com



Alientech – GERMANY

Wattstraße 8, 76185,
Karlsruhe Baden Württemberg

+491732877943
holger.krautt@alientech.to



Alientech – MEXICO

Juan De Sos Trevino #146 Int C Colonia San
Jeronimo C.P 64640 Monterrey Nuevo Leon

+52 81 19690196
info@mva.mx



Alientech – ARGENTINA

Isla Blanco 22
Bo. Felix U. Camet, Mar del Plata

+54 11 5263 8737
info@alientech.ar